

QUICK START GUIDE

Autel Smart Controller

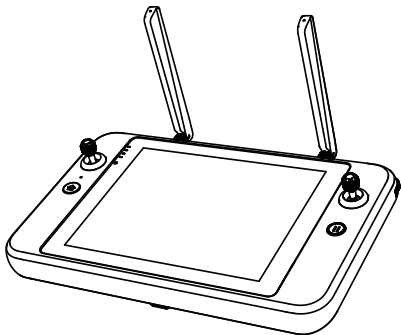

AUTEL
ROBOTICS

Contents

1. Disclaimer	1
2. Battery Safety	1
3. Precautions	1
4. Getting To Know the Autel Smart Controller	2
5. Item List	2
6. Controller Layout	4
7. Powering On the Smart Controller	5
7.1 Check the Battery Information	5
7.2 Power On/Off	6
7.3 Charging	6
8. Antenna Adjustment	6
9. Frequency Match	7
10. Flying	8
11. Command Stick Operations (Mode 2)	9
12. Specifications	10

1. DISCLAIMER

To ensure safe and successful operation of your Autel smart remote controller, please strictly follow the operating instructions and steps in this guide.

If the user does not abide by the safety operation instructions, Autel Robotics will not be responsible for any product damage or loss in use, whether direct or indirect, legal, special, accident or economic loss (including but not limited to loss of profit), and does not provide warranty service. Do not use incompatible parts or use any method that does not comply with the official instructions of Autel Robotics to modify the product.

The safety guidelines in this document will be updated from time to time. To ensure you get the latest version, please visit the official website:
<https://www.autelrobotics.com/>

2. BATTERY SAFETY

The Autel smart remote controller is powered by a smart lithium-ion battery. Improper use of lithium-ion batteries can be dangerous. Please ensure that the following battery usage, charging and storage guidelines are strictly followed.

WARNING:

- Only use the battery and charger provided by Autel Robotics. It is forbidden to modify the battery assembly and its charger or use a third-party equipment to replace it.
- The electrolyte in the battery is extremely corrosive. If the electrolyte spills into your eyes or skin accidentally, please rinse the affected area with clean water and seek medical attention immediately.

3. PRECAUTIONS

When using the Autel Smart Controller (hereinafter referred to as the "Smart Controller"), if improperly used, the aircraft may cause a certain degree of injury and damage to people and property. Please be cautious while using it. For details, please refer to the aircraft's disclaimer and safety operation guidelines.

1. Before each flight, make sure that the Smart Controller is fully charged.
2. Make sure the Smart Controller antennas are unfolded and adjusted to the appropriate position to ensure the best possible flight results.







3. If the Smart Controller antennas are damaged, it will affect the performance, please contact the after-sales technical support immediately.
4. If the aircraft is changed, it needs to be repaired before using.
5. Make sure to turn off the aircraft power before turning off the remote controller each time.
6. When not in use, make sure to fully charge the smart controller every three months.
7. Once the power of the smart controller is less than 10%, please charge it to prevent an over-discharge error. This is caused by the long-term storage with a low battery charge. When the smart controller will not be in use for an extended time, discharge the battery between 40%-60% before storage.
8. Do not block the vent of the Smart Controller to prevent overheating and diminished performance.
9. Do not disassemble the smart controller. If any parts of the controller are damaged, contact Autel Robotics After-Sale Support.

4. AUTEL SMART CONTROLLER

The Autel Smart Controller can be used with any supported aircraft, and it provides a high-definition real time image transmission and it can control the aircraft and camera up to 13km (8.08 miles) [1] communication distance. The Smart Controller has a built-in 7.9-inch 2048x1536 ultra-high-definition, ultra-bright screen with a maximum 2000nit brightness. It provides clear image display under the bright sunlight. With its convenient, built-in 128G memory it can store your photos and videos on board. The operating time is about 4.5 hours when the battery is fully charged and the screen is at 50% brightness [2].

5. ITEM LIST

NO	DIAGRAM	ITEM NAME	QTY
1		7.9 inch Smart Remote Controller	1PC

2		Smart Controller Protective Case	1PC
3		A/C adapter	1PC
4		USB Type-C cable	1PC
5		Chest Strap	1PC
6		Spare Command Sticks	2PCS
7		Documentation (Quick Start Guide)	1PC

- [1] Fly in an open, unobstructed, electromagnetic interference-free environment. The smart controller can reach the maximum communication distance under FCC standards. Actual distance may be less based on the local flight environment.
- [2] The above-mentioned working time is measured in a laboratory environment at room temperature. The battery life will vary in different usage scenarios.

6. CONTROLLER LAYOUT

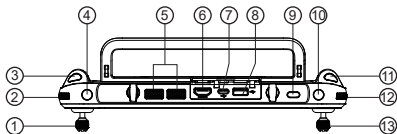

Top view

- | | | |
|-----------------------------|----------------------------|--------------------------|
| 1. Left Command Stick | 5. Air Outlet | 11. Photo Shutter Button |
| 2. Gimbal Pitch Angle Wheel | 6. HDMI Port | 12. * Zoom Control Wheel |
| 3. Video Recording Button | 7. USB TYPE-C Port | 13. Right Command Stick |
| 4. Customizable Button C1 | 8. USB TYPE-A Port | |
| | 9. Power Button | |
| | 10. Customizable Button C2 | |

*The function may alter, please take the practical effect as standard.

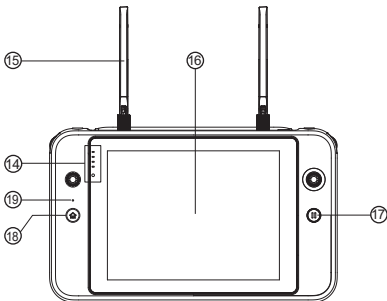

Front view

- | | |
|-----------------------|---------------------------------|
| 14. Battery Indicator | 17. Pause Button |
| 15. Antenna | 18. Return to Home (RTH) Button |
| 16. Touch Screen | 19. Microphone |

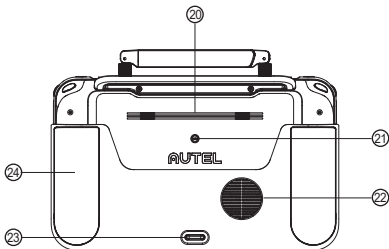

Rear view

20. Speaker hole

21. Tripod Mount Hole

22. Air Vent





23. Bottom Hook

24. Grips

7. POWER ON THE SMART CONTROLLER

7.1 Check Battery Level

Press the power button to check the battery life





	<p>1 light solid on: Battery \geq 25%</p>
	<p>2 lights solid on: Battery \geq 50%</p>
	<p>3 lights solid on: Battery \geq 75%</p>
	<p>4 lights solid on: Battery \geq 100%</p>

7.2 Powering on/off

Press and hold the power button for 2 sec to turn on and off the Smart Controller.

7.3 Charging

Remote Controller indication light status

	1 light solid on: Battery \geq 25%
	2 lights solid on: Battery \geq 50%
	3 lights solid on: Battery \geq 75%
	4 lights solid on: Battery \geq 100%

 **NOTE:** LED indication light will blink while charging

8. ANTENNA ADJUSTMENT

Unfold the Smart Controller antennas and adjust them to the optimal angle. The signal strength varies when the antenna angle is different. When the antenna and the back of the remote controller are at an angle of 180° or 260°, and the antenna surface is facing the aircraft, the signal quality of aircraft and controller will reach the optimal condition.

NOTE:

LED indicator will flash while charging

- Do not use other communication equipment which has the same frequency band at the same time, to avoid the interference to the Smart Controller signal.

- During operation, the Autel Explorer app, will prompt the user when the image transmission signal is poor. Adjust the antenna angles according to the prompts to ensure the Smart Controller and aircraft have the best communication range.

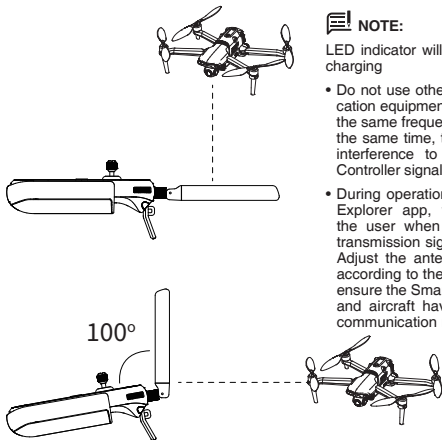

9. FREQUENCY MATCH

When the Smart Controller and the aircraft are purchased as a set, the Smart Controller has been matched to the aircraft at the factory, and it can be used directly after the aircraft is activated.

If purchased separately, please use the following 2 methods to link.

Method 1:

1. Press (short press) the linking button next to the USB port on the right side of the aircraft body to put the aircraft into the linking mode;
2. Power on the Smart Controller and run the Autel Explorer app, enter the mission flight interface, click the gear icon in the upper right corner, enter the settings menu, click "remote control -> data transmission and image transmission linking> start linking", wait a few seconds until the transmission is set correctly and the linking is a success.

Method 2:

1. Press (short press) the linking button next to the USB port on the right side of the aircraft body to put the aircraft into the linking mode;

2. Press and hold the Power Button and Go Home Button simultaneously for 2 seconds, wait a few seconds until the transmission is set correctly and the linking is a success.



10. FLIGHT



Open the Autel Explorer app and enter the flight interface.

Before takeoff, place the aircraft on a flat and level surface and face the rear side of the aircraft towards you.

Manual takeoff and landing (Mode 2)

Toe in or out on both command sticks for about 2 seconds to start the motors

Manual Takeoff	
 or 	 Push up slowly Left Command Stick (mode 2)

Manual landing	Automatic takeoff and landing
 Push down slowly Left Command Stick (Mode 2)	 Press and hold the take-off/landing button 3 seconds

NOTE:

Before takeoff, place the aircraft on a flat and level surface and face the rear side of the aircraft towards you.

Mode 2 is the default control mode of the Smart Controller. During the flight, you can use the left stick to control the flight altitude and direction, and use the right stick to control the forward, backward, left and right directions of the aircraft.

NOTE:

- Please make sure that the Smart Controller has successfully matched with the aircraft.
- For more functions of the Smart Controller, please read the user manual for details

11. Command Stick Control (Mode 2)

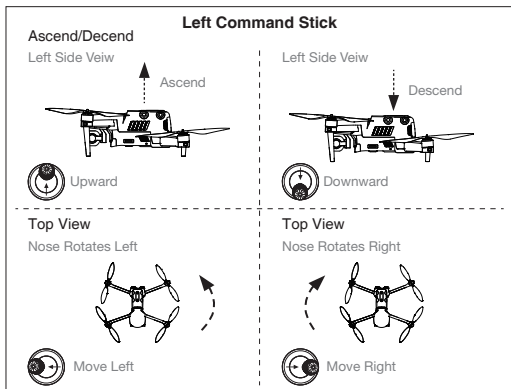

Right Command Stick

Left Side Veiw

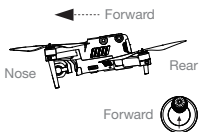

Left Side Veiw

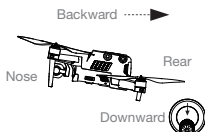

Rear View

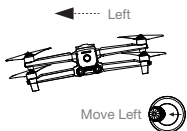

Rear View

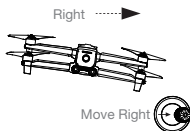

12. Specifications

Image Transmission

*Working Frequency	902-928 MHz 2.400-2.4835 GHz 5.725-5.850 GHz
--------------------	--

Max Signal Transmission Distance (No interference, No obstacles)	FCC: 13 km CE: 7 km
---	------------------------

Digital transmission

Working Frequency	5.725 - 5.755 GHz
-------------------	-------------------

Transmitter Power (EIRP)	5.725-5.755GHz FCC: ≤20dBm CE: ≤14dBm
--------------------------	---

Wi-Fi

Protocol	Wi-Fi Direct, Wi-Fi Display, 802.11a/b/g/n/ac Support 2 x 2 MIMO Wi-Fi
* Working Frequency	2.400 - 2.4835 GHz; 5.150 - 5.250GHz; 5.725 - 5.850 GHz
Transmitter Power (EIRP)	2.400 - 2.4835 GHz FCC/CE: ≤20dBm 5.150 - 5.250GHz FCC: ≤17dBm 5.725 - 5.850 GHz FCC: ≤17dBm CE: ≤14dBm

Other Specifications

Battery	Name: Intelligent Li-ion battery Capacity: 5800mAh Voltage: 11.55V Battery Type: Li-ion Battery Energy: 67 Wh Charging time: 120 min
Operating Hours	~ 3h (Max Brightness) ~ 4.5 h (50% Brightness)
Internal Storage	128GB
Video Output Port	HDMI Port
USB-A Voltage/Current	5V / 2A
Operating Temperature	-20 ℃ to 40 ℃
Storage Temperature	-20 ℃ to 45 ℃ (<1 month) 0 ℃ to 30 ℃ (1-3 months) 15 ℃ to 25 ℃ (<1 year)
Charging Temperature	5 ℃ to 45 ℃

**Supported Aircrafts	EVO II Series EVO II RTK Series EVO II Enterprise
Satellite Positioning Module	GPS + GLONASS + Galileo
Dimensions	303×190×87mm (with antenna folded) 303×273×87mm (with antenna unfolded)
Weight	1150g (without protective case) 1250g (with protective case)

 **NOTE:**

- * The working frequency band varies according to different countries and models.
- ** We will support more Autel Robotics aircraft in the future, please visit our official website <https://www.autelrobotics.com/> for the latest information.

AUTEL

WWW.AUTELROBOTICS.COM

© 2020-2021 Autel Robotics Co., Ltd. All Rights Reserved